

2001 and Newer

BRAUN



ENTERVAN

## Operator's Manual



"Providing Access to the World"®

International Corporate Hdqrs: P.O. Box 310 Winamac, IN 46996 USA  
1-800-THE LIFT (574) 946-6153 FAX: (574) 946-4670



27854

June 2002



Entervan® II

**WARNING**



Read manual before operating. Failure to do so may result in serious bodily injury and/or property damage. Keep manual in Entervan.

Braun Entervan® II

# Congratulations

We at The Braun Corporation wish to express our fullest appreciation on your new purchase. With you in mind, our skilled craftsmen have designed and assembled the finest lowered floor vehicle available.

This manual includes safety precautions, operating instructions, manual operating instructions, and instructions for maintenance and lubrication procedures.

Your Entervan® II is built for dependability, and will bring you years of pleasure and independence, as long as the maintenance is performed regularly and the Entervan® is operated by an instructed person.

Sincerely,

THE BRAUN CORPORATION

A handwritten signature in black ink that reads "Ralph W. Braun". The signature is written in a cursive style with a large, sweeping "B" and "R".

Ralph W. Braun  
Chief Executive Officer

<b>WARRANTY AND REGISTRATION INSTRUCTIONS</b> .....	2	Swing Out Ramps .....	19
<b>INTRODUCTION</b> .....	3	Ramp Safety .....	20-22
<b>ENTERVAN OPERATION QUICK REFERENCE GUIDE</b> .....	4, 5	<b>WHEELCHAIR AND OCCUPANT RESTRAINT</b> .....	23-31
<b>FEATURES</b> .....	6, 7	<b>SEAT REMOVAL AND INSTALLATION</b>	
<b>SAFETY PRECAUTIONS</b> .....	8	Front Seats (General Information) .....	32
<b>OPERATION</b>		Seat Base Rear Covers .....	33
Terminology .....	9	Seat Electrical Harnesses .....	34-38
One-Touch Control System .....	9	Easy-Out Roller Seat Base .....	39, 40
Control Switches .....	10-12	Bolt-in Front Seat Base .....	41-43
Ramp Access Sliding Door .....	13	Bolt-in Rear Seat Base .....	44, 45
Kneel System .....	14, 15	<b>WARRANTY</b> .....	46-49
Ramp .....	16, 17	<b>PREVENTIVE MAINTENANCE</b> .....	50, 51
Manual Ramp Operation .....	18	<b>JACKING AND TIRE CHANGING</b> .....	51
		<b>AUXILIARY POWER SUPPLY / BELOW FLOOR OBSTRUCTIONS</b> .....	52-54

## WARRANTY AND REGISTRATION INSTRUCTIONS

Examine your Entervan® for any damage. Should any damage have occurred during delivery, notify the carrier at once with any claims.

Two warranty/registration cards are supplied with each Entervan®. Your sales representative must process one of the cards. You, the consumer, must fill out the second card and mail it to The Braun Corporation.

A detailed Warranty section is provided within this manual. The **warranty cards must be processed to activate the warranty.**

The last eight digits of the vehicle identification number (VIN) are provided on the warranty cards. Record the VIN in the space provided for future reference. **This information must be provided when filing a warranty claim or ordering parts.**

Vehicle Identification (VIN) Number \_\_\_\_\_

Last Eight Digits of  
Vehicle Identification Number

<b>OWNER'S WARRANTY REGISTRATION</b>	
Y B 7 3 9 4 8 7 _____	
PURCHASED FROM _____	
OWNER	
NAME _____	DATE INSTALLED _____
ADDRESS _____	
CITY _____	
TELEPHONE _____	STATE _____ ZIP _____
<small>TO VALIDATE WARRANTY REGISTRATION CARDS MUST BE RETURNED TO THE BRAUN CORPORATION.</small>	

Sample Warranty Registration Card

The Braun Entervan lowered floor conversion is designed to provide years of pleasure and mobility independence. Familiarity with proper operation and maintenance procedures will help ensure safe, troublefree operation.

The Braun Corporation encourages wheelchair passengers and their attendant(s) to review the material contained in this manual with your Entervan sales representative, **before attempting operation.** Any questions or concerns can be answered by your sales representative at that time.

This manual addresses Entervan standard features as well as options. Refer to the instructions applicable for your package, and disregard the information that does not apply. Contact The

Braun Corporation at 1-800-THE LIFT if any of this information is not understood.

The Entervan Operation Quick Reference Guide hanging on the mirror provides a condensed explanation of Entervan operation (shown at right). Read the guide and then insert it in this manual for future reference. **Note:** An Operation Quick Reference Guide (overview) section is provided on pages 4 and 5 of this manual also.

Store this manual in the vehicle along with your Chrysler owner's manual.

If you experience an operation problem or there is any sign of wear, damage, or other abnormal condition, contact your sales representative or call The Braun

Corporation at 1-800-THE LIFT. One of our national Product Support representatives will direct you to a Braun authorized service center.



Operation Quick Reference Guide

### Entervan Operation Overview

This overview provides a simplified explanation of Entervan operation. Read the entire owner's (operator's) manual for complete details. Contact The Braun Corporation at 1-800-THE LIFT if any of this information is not understood.

### Power Operation

Entervan power functions are managed by the One-Touch electronic control system. The control system can be activated using the Chrysler remote keyless entry transmitter, any one of five interior-mounted control switches, the outside key entry or the optional magnetic entry.

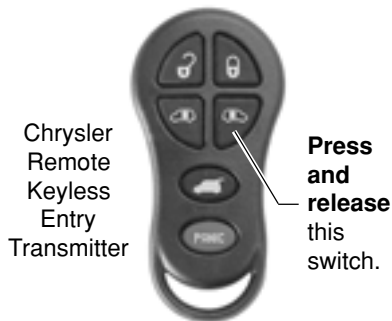

Control switches display the slide door graphic.



### One-Touch Control Activation

Entervan power door, ramp and kneel functions are activated by **pressing and releasing** any control switch.

**Open Functions:** When activating the Open functions, the power door opens, the kneel system lowers the rear of the vehicle and the ramp unfolds.

**Close Functions:** When activating the Close functions, the ramp folds, the kneel system raises the rear of the vehicle and the power door closes.

### Manual Operation

In event of power or equipment failure, the door, ramp and kneel system can be manually operated. Read this manual for further details.

**Operating Your New Entervan Couldn't Be Simpler . . .**



**1** Just press any one of the buttons like the one pictured above . . .

**2** And the sliding door opens

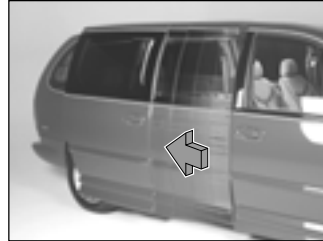

**3** The rear suspension lowers

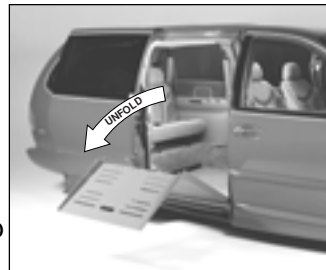

**4** The ramp unfolds



Allowing easy entrance!

## FEATURES

**One-Touch Electronic Control System:** The Entervan One-Touch electronic control system provides simple one-touch activation of all Entervan power features. For your convenience, the control system can be activated using the Chrysler remote keyless entry transmitter, any one of five interior-mounted control switches, the outside key entry or the optional magnetic entry (control photos and details are provided).

**Power Slide Door:** The One-Touch electronic control system activates the Chrysler passenger side power slide door for ramp access. The slide door and lowered floor configuration provides 53" clear vertical passageway. **Note:** The driver-side sliding door is lowered to provide clear passage also.

**Ramp:** Fully automatic power ramps and manually operated ramps are available in 29" width (**optional** swing-out feature available), and 30" width (non-swing **only**).

**Electromechanical Power Kneeling Rear Suspension:** "Kneeling" is the lowering motion of the electromechanical rear suspension. The kneel feature reduces the slope of the ramp when deployed.

**Lowered Floor from Rear Axle to Firewall:** This feature provides additional headroom (57-1/2" floor-to-ceiling at center of van), and further reduces the slope of the ramp when deployed. Chrysler factory carpeting is featured throughout the lowered floor area.

**Ground Effects:** Exterior color matched ground effect panels conceal the lowered floor and lowered sliding doors.

### **Floor Track for Wheelchair and Occupant Securement in Midpoint Lowered Floor Area:**

Floor track provided in the midpoint lowered floor area (Position **C**) can be utilized for restraint of wheelchair passenger(s). Wheelchair capacity at midpoint may have limitations based on the dimensions of specific wheelchairs.

### **Forward-Facing Wheelchair and Occupant Belt/Track**

**System:** One Forward-Facing Wheelchair and Occupant Belt Kit is supplied for the restraint of one wheelchair and occupant.



The belt kit is used in conjunction with the floor track. **Note:** Additional belt kits can be purchased (option).

**Quick-Release Front Passenger Seat with Floor Track for Wheelchair and Occupant Securement:**

The passenger seat (Position **B**) is equipped with Chrysler's Easy-Out® seat attachments (making seat removal and installation procedures simple). "Easy-Out® Rollers" is a registered trademark of DaimlerChrysler Corporation. The seat can be removed and the seat location can be utilized by a wheelchair occupant (floor track provided).

**Driver Seat:** For the wheelchair occupant who chooses to drive the Entervan, this seat (Position **A**) can be removed and adaptive

driving systems custom tailored for the individual can be purchased from and installed by your local mobility dealer. The driver's seat is available with Chrysler's Easy-Out® seat attachments or with a bolt-in seat base. 56-1/2" floor-to-ceiling headroom is provided at both front seating positions.

**Auxiliary Power Supply for Dealer-Installed Power Seat or Electric Tie-Downs:** This power source is available to accommodate adaptive driving systems custom tailored for the individual (purchased from and installed by your local mobility sales representative). See pages 52-54.

**Interior Spare Tire Mount:** The spare tire is mounted behind the rear bench seat. The jack is stored with the spare tire.

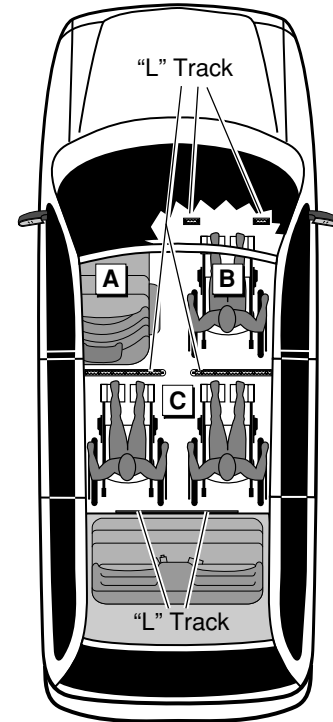

Available Wheelchair Positions

## SAFETY PRECAUTIONS

### Safety Symbols

#### SAFETY FIRST! Know That....

**A** All information contained in this manual and supplements (if included), is provided for your safety. Familiarity with proper operation instructions as well as proper maintenance procedures are necessary to ensure safe, troublefree operation. Safety precautions are provided to identify potentially hazardous situations and provide instruction on how to avoid them.

**B**



**C**

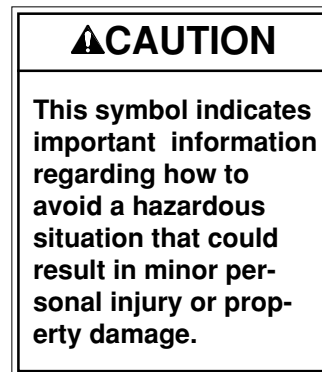

**D** **Note:** Additional information provided to help clarify or detail a specific subject.

These symbols will appear throughout this manual and may appear on labels posted on your Entervan.  
**Recognize the seriousness of this information.**

Whenever parking your Entervan and before utilizing Entervan features, always engage the vehicle transmission in Park “P” and engage the vehicle parking brake. The vehicle transmission **must** be engaged in Park “P,” before operating the Entervan automatic features. Entervan power function control switches cannot be activated if the vehicle transmission is not in Park.

### **Terminology**

“Kneeling” is the lowering motion of the Entervan electromechanical rear suspension. The term “Unfold” indicates the lowering motion of the ramp to the deployed position. “Fold” is the raising motion of the ramp to the vertical (stowed) position.

The terms “Open” and “Close” refer to sequences of power functions that will occur when activated by the One-Touch electronic control system. When activating the Open functions, the power door opens, the kneel system lowers the rear of the vehicle and the ramp unfolds. When activating Close functions, the ramp folds, the kneel system raises the rear of the vehicle and the power door closes.

### **One-Touch Control System**

Entervan power functions are managed by the One-Touch electronic control system. The control system can be activated using the Chrysler remote keyless entry transmitter or any one of the controls addressed on pages 10 -12).

**Do not** attempt to interface aftermarket control systems.

### **Braun Corporation Aftermarket Control Systems Policy:**

The Braun Corporation manufactures dedicated control systems for its products. These control systems have been designed and tested for use in conjunction with specific Braun products. Braun control systems are the **only** control systems authorized for use with Braun products.

**Do not** attempt to interface aftermarket control systems without authorization from The Braun Corporation. **To do so may result in serious bodily injury and/or property damage.**

## OPERATION

### Control Switches

For your convenience, the Entervan One-Touch electronic control system can be activated using the Chrysler remote keyless entry transmitter or anyone of four interior-mounted control switches (details at right).

### One-Touch Control Activation

Entervan power door, ramp and kneel functions are activated by **pressing and releasing** any control switch.

### Chrysler Remote Keyless Entry Transmitter

Using the Chrysler remote keyless entry transmitter eliminates the need of an additional remote control.



**Remote and Console Switches:** Press switch displaying this slide door graphic.



### Center Console Switches

For front seat passengers, switches are located on both sides of the center console.



**Overhead Console Switch**

For front seat passengers, one switch is located in the overhead console.



**Press and release** this switch.

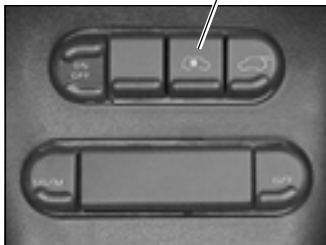

**“B” Pillar Switch**



**Press and release** this switch.

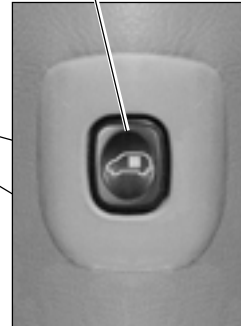

A switch is located on the wall panel ahead of the passenger side slide door (“B” pillar).

**“C” Pillar Switch**



A switch is located on the wall panel rear of the passenger side slide door (“C” pillar).

**Passenger Side Switches:** Press switch displaying this slide door graphic. 

## OPERATION

### Outside Key Entry

Entervans manufactured after 10-19-01 are equipped with an outside key entry system incorporated in the passenger side front door lock (standard equipment). Insert the key and turn it either direction to activate Entervan power door, ramp and kneel functions.

**Delay Feature:** When activating the Open functions using the outside key entry, the key unlocks the door and then there is a **one second delay before** the Entervan Open sequence of functions is activated. The One-Touch electronic control system unlocks the front passenger door and the passenger side slide door before activating Entervan power door, ramp and kneel functions.

### Magnetic Entry

The magnetic entry is offered as an **option**. A magnetic switch is built into the rear passenger-side taillight assembly. The switch is labeled OPEN/CLOSE.

A pen-style magnet is supplied for switch activation. Simply remove the pen cap and align the magnet tip with the switch target (identified with decal 28013). Entervan power door, ramp and kneel functions will be activated.

**Delay Feature:** When activating

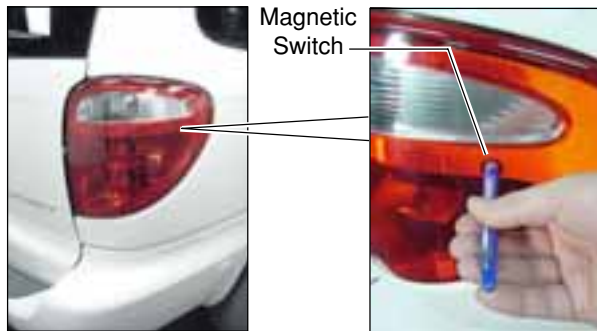

Passenger-side  
Taillight Assembly

Align magnetic  
tip with switch.

the Open functions using the magnetic entry, there is a **one second delay before** the Entervan Open sequence of functions is activated. As with the key entry, the One-Touch electronic control system unlocks the front passenger door and the passenger side slide door before activating Entervan power functions.

### Ramp Access Sliding Door

The passenger side power sliding door may be opened using the Entervan One-Touch Control System or it may be opened manually. Press and release the Chrysler remote keyless entry transmitter or any one of the interior-mounted control switches to activate the door. When a control switch is pressed, the door will open and the Open sequence of functions will continue.

If a control switch is pressed and released while the door is opening, the door will open fully and stop. Press the switch again and the door will close.

Once the Open sequence of functions is complete (door is fully open and ramp is unfolded), press

and release a control switch to close the door. The door will close after the ramp folds and the vehicle raises, completing the Close sequence of functions.

If a control switch is pressed while the door is closing, the door will reverse direction. Stopping and reversing the door will not activate the remaining sequence of Open functions. Press a control switch again to start Open functions.

If the inside or outside door handles are pulled out while the power door is opening or closing, the power feature will be deactivated and the door must be opened or closed manually. The door must be opened fully or closed fully before the power features can be activated again.

**Note:** If the power door is obstructed while opening or closing, the door will reverse direction, provided it meets sufficient resistance.

Keep clear of the area in which the power door operates. Ensure door travel path is clear. Personal injury or property damage may occur during power door operation. Be sure the door is fully closed and latched before driving.

#### **WARNING**

**Keep clear of area in which power door operates. Failure to do so may result in bodily injury and/or property damage.**

## OPERATION

### Kneel System

Kneeling is the lowering motion of the Entervan electromechanical rear suspension (option). The kneel system lowers the rear of the vehicle. Lowering the rear of the vehicle reduces the slope of the ramp.

The kneel system is automatically activated by the One-Touch electronic control system. When a control switch is pressed to start the Open functions, the rear of the vehicle lowers after the door starts to open. When the Close functions are activated, the vehicle raises after the ramp starts to fold.

**Note:** Do not leave your Entervan in the kneeled (lowered) position for extended

periods of time. Doing so may result in battery drain.

**Kneel On-Off Feature:** A Kneel On-Off feature has been incorporated into the One-Touch electronic control system (effective 7-17-01). This feature provides the **option** of kneeling the vehicle when operating the power door and power ramp.

**Kneel On-Off Activation:** To turn the kneel feature on and off, Entervan power features must be in the Closed mode, (the ramp must be folded and the door must be fully closed). This feature can **only** be activated using the driver side center console control switch.

Kneel On-Off feature can **only** be activated using the driver side center console control switch.

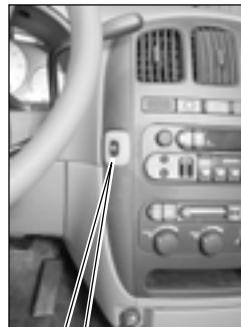

Activate **Kneel On-Off Feature** with this switch.



**To Turn Kneel Off:** Press and hold the center console control switch a minimum of three seconds. The Open sequence of functions will start as normal (door opens and ramp unfolds). The kneel system will not be activated.

The kneel system will remain off until it is reactivated (vehicle will not lower or raise during open and close sequences).

**To Turn Kneel On:** Repeat the procedure. Press and hold the center console control switch a minimum of three seconds. The full Open sequence of functions will start (door opens, kneel lowers rear of vehicle and the ramp unfolds).

**Mechanical Kneeling Override:**

In the event the Entervan is in the kneeled position and you experience power or equipment failure, the Kneel Actuator Manual Release (Override) feature allows the rear of the vehicle to be raised to the normal position.

Use the Kneel Manual Release **only** if the vehicle will not raise electrically. **Do not** drive the Entervan with the rear of the vehicle in the lowered position. Attempting to do so will result in an extremely rough and unstable ride. In the event of a kneel system failure, have the kneel system repaired immediately.

A black T-handle is located under the rear bench seat. Turn the T-release handle clockwise **until vehicle raises**. Stop turning the

handle when the vehicle raises.

**Note:** Turn the T-release handle counterclockwise a minimum six full revolutions **before performing electrical procedures**.

**T-Handle Storage Note:** The T-release handle can be removed from it's receptacle and stored in the glove box or other location if needed.

Manual Release T-Handle

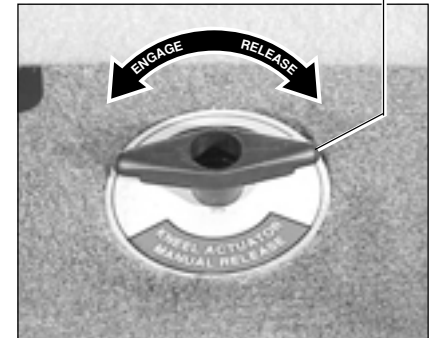

## OPERATION

### Ramp

**Power Ramp Operation:** The power ramp is activated by the One-Touch electronic control system. When a control switch is pressed to start the Open functions, the ramp unfolds after the door is fully open. When the Close functions are activated, the ramp folds immediately.

If a control switch is pressed and released while the ramp is unfolding, the ramp motor will stop running. Press a switch again and the ramp will fold, the vehicle will raise and the door will close.

Once the Open sequence of functions is complete (door is fully open and ramp is unfolded), press and release a control switch to fold the ramp.

If a control switch is pressed while the ramp is folding, the ramp motor will stop running. Press a control switch again and the ramp will unfold.

**Note:** If the power ramp is obstructed while unfolding or folding, the ramp motor will stop running,

provided it meets sufficient resistance. If the ramp is obstructed during the unfold cycle, press the switch again and the ramp will fold, vehicle will raise and the door will close. If obstructed during the fold cycle, press the switch again and the ramp will unfold.

**Note:** When unfolding the ramp, the ramp motor stops running when the ramp reaches the nearly-horizontal position (approximately 6" - 8" above ground level). The ramp continues to slowly lower the remaining distance by the force of gravity.

Allow the power ramp to unfold (deploy) fully before boarding the ramp. Forcing the ramp out or down during the unfold function, or boarding onto the ramp before it is fully-deployed **may result in damage** to the ramp and/or motor assembly.

### **CAUTION**

**Allow ramp to deploy fully before boarding. Failure to do so may result in damage.**

**Power Ramp Safety:** Be certain there is adequate clearance outside the Entervan before unfolding the power ramp.

Keep clear of area in which the ramp operates. Be certain no person or obstruction is within the path of the ramp when unfolding or folding the ramp. Keep clear of all power ramp moving parts. Do not attempt to grip or hold the ramp or ramp folding mechanism (fold arm and bearing assembly).

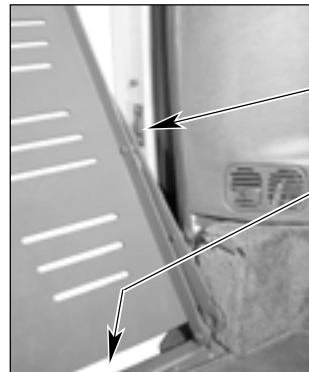
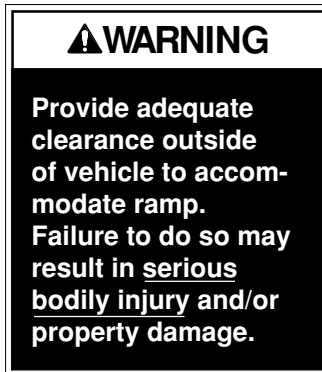

Keep body parts and obstructions clear of the area in which the ramp operates.

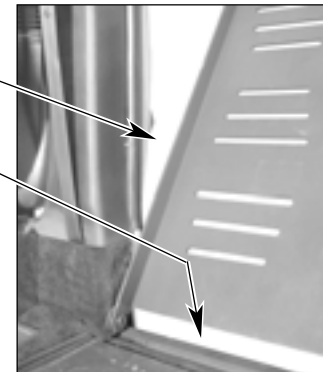

## OPERATION

**Manual Operation:** If you experience power or equipment failure, power ramps can be manually folded and unfolded. Have an assistant manually

Use the **HAND HOLD** to **carefully** unfold and fold the ramp.

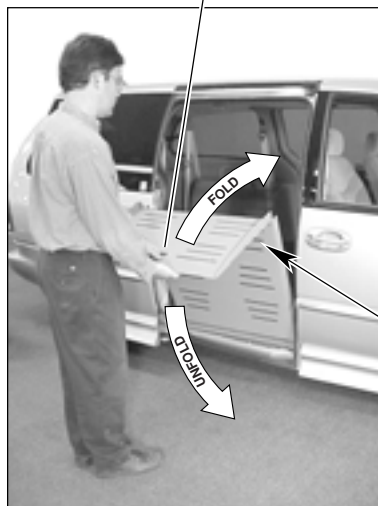

Keep clear of hinge area.

unfold and fold the ramp. Push ramp out **only** if assistant is not available.

**Manual Ramp Operation:** Manual ramps must be manually unfolded and folded by an attendant. An oval-shaped **HAND HOLD** slot is provided on the ramp (see photo at left). **Carefully** unfold and fold the ramp using the **HAND HOLD**.

Keep clear of the area in which the hinged ramp bifold extension folds and unfolds. Remember to use good body mechanics when folding and unfolding the ramp.

The safety precautions addressed in the Power Ramp section apply to use of a manual ramp also. **Read and become familiar with all ramp safety precautions.** Follow these additional precautions exclusive for manual ramps also. Do not release the ramp when manually unfolding or folding the ramp. The ramp will free-fall. Do not push the ramp out from inside the vehicle. The ramp will free-fall.

## Swing Out Ramps

When in the stowed (folded) position, swing-out ramp assemblies can be manually rotated out of the slide door opening (29" swing-out ramps only). This feature allows non-wheelchair access to the passenger side slide door opening.

The front end of the ramp is secured to the vehicle floor with a cable activated spring-loaded latch. The ramp assembly pivots (rotates) on two axles (top and bottom) when the ramp latch is disengaged.

The latch is activated by a release cable. The release cable is routed upward through the front slide door post (B-pillar). The cable is equipped with a latch release (see Photo A). The release is located in

the door post interior trim panel just in front of the slide door (B-pillar).

The sliding door **must be opened fully before** the ramp can be rotated (swung out). **Power Door:** Press and release a control switch to open the door. While the door is opening, press the switch again. The door will open fully and stop. The power door can be manually opened if desired.

Lift the release to unlatch the ramp. See Photo A. Manually rotate the ramp out. See Photo B.

**Caution: Do not** force ramp open. **Do not** press a control switch when the latch is disengaged or the ramp is rotated out of vehicle. **Do not** attempt to manually fold or unfold the ramp when the ramp is rotated out of vehicle.

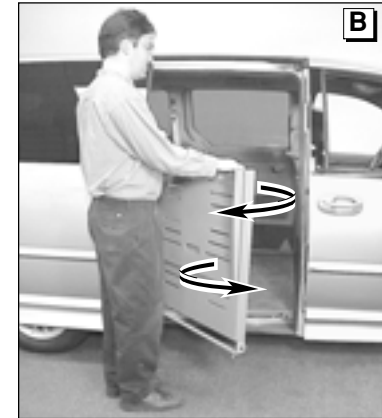
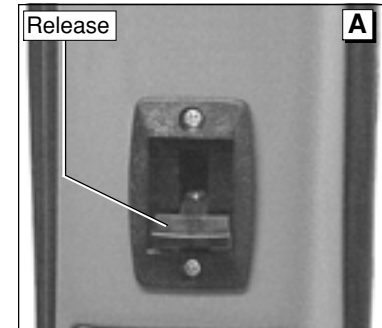

### Ramp Safety

Wheelchair passengers and attendants (when applicable), must use basic common sense and good judgment regarding ramp safety. Each wheelchair passenger has a unique set of physical abilities combined with the physical characteristics of his or her wheelchair that dictate the method in which he or she will enter and exit the Entervan. Consequently, the procedures for safe operation outlined in this manual are general in nature. Wheelchair attendants should be instructed on any special needs and/or procedures required for safe transport of wheelchair passengers.

Follow all safety instructions regarding torso restraints, stability, balance, weight distribution and use of attendants as specified in the owner's manual supplied with **your** wheelchair. Determine, establish and practice ramp boarding and exiting procedures under the direction of your health care professional, your wheelchair representative, and your Entervan sales representative to **ensure your ability to do so safely**.

Never board an Entervan ramp if you or your attendant are intoxicated. The wheelchair should be positioned in the center of the ramp at all times. You must be able to clearly view the ramp whenever boarding and exiting the vehicle.

**It is the responsibility of the wheelchair operator to enter and exit the Entervan on the ramp in the safest manner.**

#### **Wheelchair-Equipped Occupant Seat Belts:**

Wheelchair passengers should position and buckle their wheelchair-equipped seat belt (torso restraint), as specified by the manufacturer, **before** loading onto a wheelchair ramp.

Different types of disabilities require

#### **⚠ WARNING**

**Position and fasten the wheelchair-equipped occupant seat belt before loading onto the wheelchair ramp. Failure to do so may result in serious bodily injury and/or property damage.**

different types of wheelchairs and different types of wheelchair-equipped occupant restraint belt systems (torso restraint). It is the responsibility of the wheelchair passenger to have his or her wheelchair equipped with an occupant restraint (seat belt) under the direction of their health care professional.



**Stabilizing Wheelchairs:** Powered and manual wheelchairs are designed to remain upright and stable during normal operation. All activities which involve movement in a wheelchair have an effect on the combined center of gravity of the occupant and wheelchair. Be aware of the Entervan ramp slope (angle). The slope of the ramp has a direct effect on the center of gravity. Keep in mind your center of gravity and your ability to maintain stability and balance.

Do not operate your wheelchair on the Entervan ramp without assistance if you are unable to maintain

stability and balance. Counterbalance devices (anti-tippers) may be available from your wheelchair representative to enhance stability and balance.

Do not tilt your wheelchair without assistance. Operate the wheelchair at a slow and constant speed when on the ramp. Do not accelerate suddenly when on the ramp. Do not raise the front wheelchair wheels (pull wheelie) when on the Entervan ramp.

The aid of an attendant stabilizing the wheelchair is recommended for **optimum safety**. Wheelchair

## OPERATION

passengers who intend to enter and exit their Entervan without the assistance of an attendant must determine the safest and most practical method and orientation of entering and exiting the Entervan based on the physical characteristics of their personal wheelchair and his or her physical capabilities to maintain stability while the wheelchair is in motion on the Entervan ramp.

**Wheelchair Attendants:** When assisting a wheelchair occupant, remember to use good body mechanics. When the wheelchair is on the ramp, the attendant must grasp the push handles (or other) securely. Detachable wheelchair parts such as arms or legrests must never be used for hand holds or lifting supports. Doing so could result in the detachable parts being inadvertently detached from the wheelchair **resulting in possible injury to the wheelchair occupant and/or the attendant.**

**Wheelchair Orientation and Securement During Transport:** The wheelchair and occupant **must** face the front of the vehicle and **must** be secured using the Forward-Facing Wheelchair and Occupant Belt and Track System when riding in the Entervan. See pages 23-31 for details.



## WHEELCHAIR AND OCCUPANT RESTRAINT

One Forward-Facing Wheelchair and Occupant Belt Kit is supplied for the restraint of one wheelchair and occupant (details follow). “L” track is mounted in three locations in the vehicle for belt securement (shown in Figure 1).

**Note:** Wheelchair passengers shown in Figure 1 depict the available seating positions. Wheelchair capacity at Midpoint (Position C) may have limitations based on the physical dimensions of specific wheelchairs. Additional Forward-Facing Wheelchair and Occupant Belt Kits must be purchased for the restraint of each additional wheelchair passenger.

The Entervan offers the following options for placement and securement of wheelchair passengers.

**Driver Seat:** This seat (Position A) can be removed and adaptive driving systems custom tailored for the driving wheelchair occupant can be purchased from and installed by your local sales representative.

**Front Passenger Seat with Floor Track:** The passenger seat (Position B) can be removed and the seat location can be utilized by a wheelchair occupant.

**Midpoint Lowered Floor Area with Floor Track:** The Midpoint lowered floor area (Position C) can be utilized by wheelchair occupants (capacity limitations apply).

Refer to the following guidelines, illustrations, photos and instructions for proper use of the belt and track restraint system.

Available Wheelchair Positions

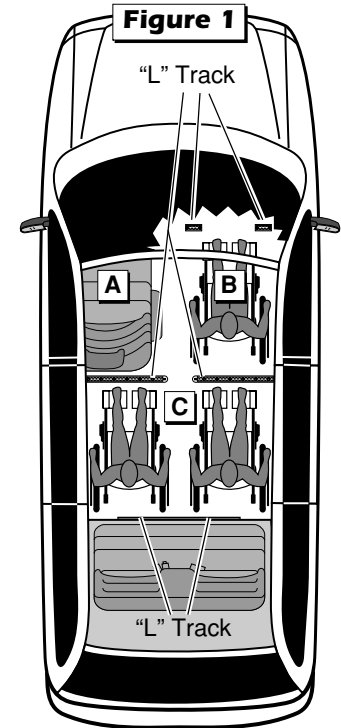

## WHEELCHAIR AND OCCUPANT RESTRAINT

### **⚠️ WARNING**

No product developed to date can guarantee successful securement of the wheelchair, even at low speeds, in the event of an accident. The Braun Wheelchair and Occupant Belt/Track System does meet the most widely referenced Federal Motor Vehicle Safety Standards used for contemporary restraint equipment. However, this equipment does not ensure stability of the wheelchair in the event of an accident at any speed.

**Wheelchair Securement:** Four adjustable over-center buckle belts are provided for securement of the wheelchair (two for the front and two for the rear).

The belts are equipped with one keeper fitting (attachment) which installs in the vehicle-mounted “L” track (details on pages 26 and 27). A hook is positioned on the opposite end of the belts for attachment to a solid frame member of the wheelchair. Do not attach belts to detachable wheelchair components such as armrests or legrests. Front and rear belt tension is required.

Refer to the illustrations, photos and instructions on pages 26-31 for belt operation procedures.

Over-Center  
Belts  
(four supplied)



Lap  
Belt  
Extension



**Wheelchair Passenger Securement:** One adjustable lap belt extension is supplied for securement of the wheelchair occupant. The extension belt is equipped with a keeper fitting (attachment) which installs in the vehicle-mounted “L” track. A female receptacle is positioned on the opposite end of the extension belt for attachment to a Chrysler factory-installed upper torso lap and shoulder belt. See the illustrations on pages 28 and 29 and photos on page 31.

Operate the Chrysler lap and shoulder belt as instructed in your Chrysler owner’s manual. Follow all safety precautions. Connect the Chrysler lap and shoulder belt to the lap belt extension. Position the upper torso (shoulder) belt across the center of the shoulder. Position the lap belt low across the front of the pelvis (near hip). See the illustrations on pages 28 and 29 and photos on page 31.

Position of the lap belt buckle, after adjustment, is to be located near hip position. The belt is to be worn low and snugly. Adjustment of the lap belt extension is to be made at adjuster buckle. Wheelchair

occupant restraints should not be held away from the body by wheelchair components such as armrests or wheels.

Keep belts clear of sharp objects. Do not alter belts. Do not interchange belts from one position to another. Keep the supplied belts together as a complete set.

**Belt and Track Maintenance:** Inspect belt assemblies frequently. Any defects such as belt cuts, fraying or malfunctioning call for replacement of the entire belt assembly. “L” track must be clean and not worn, bent or otherwise damaged (prohibiting proper belt attachment). If there is any sign of damage, wear, abnormal condition or improper operation of belts, belt hardware (hooks, keepers, latch plate, receptacle), or track, discontinue use and replace components immediately.

Severe conditions (weather, environment, heavy usage, etc.) may require more frequent inspections. Exposure to severe conditions will dramatically reduce the life of the system.

## WHEELCHAIR AND OCCUPANT RESTRAINT

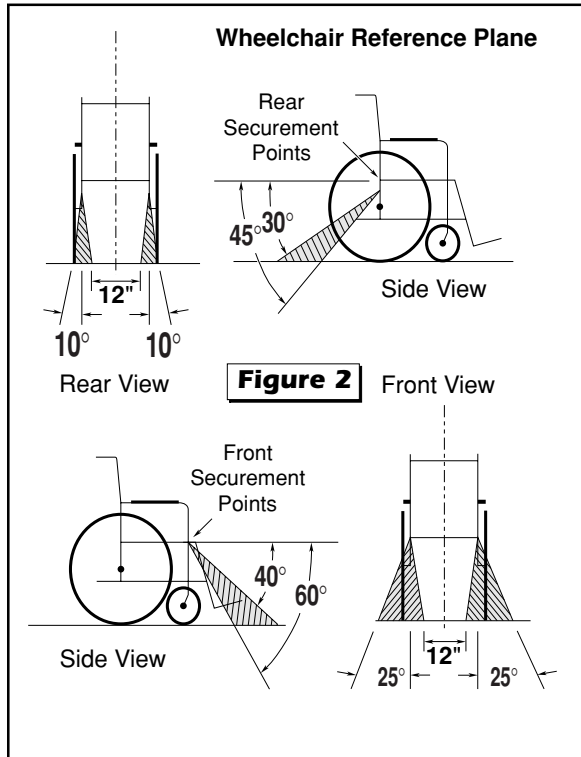

### Restraint Belt Angles:

Locate wheelchair in forward-facing position centering wheelchair squarely within “L” track. The front and rear belts, when attached, should create angles approximately as shown in Figure 2. Preferred angles and locations of belts from wheelchair securement points to vehicle anchor points are shown. Front tie-downs should be angled out far for lateral stability when possible. **Note:** These are optimum angles and cannot be achieved in some cases.

### Keeper Fitting and “L” Track Attachment Instructions:

The belts supplied in the Forward-Facing Wheelchair and Occupant Belt/Track System are equipped with keeper fittings (attachments) which engage the “L” track. Engage and release the keeper fittings as detailed and shown on page 27. **Note:** Lift to remove the “L” track plastic covers. Refer to pages 30 and 31 for belt attachment and release procedures.

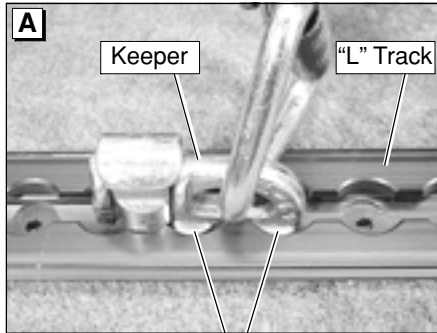

Align engagement feet with holes.



Fully-engaged Keeper

## Keeper Fitting and "L" Track Attachment Instructions:

### To Engage Keeper Fitting:

1. Insert keeper fitting into track (align two engagement feet with holes in track). See Photo A.
2. Push down on fitting and slide fitting 1/2 slot in either direction until it clicks and locks in position (see Photos B and C). Pull firmly on belt to ensure fitting is locked in track.

### To Release Keeper Fitting:

1. Lift plunger and slide fitting 1/2 slot in either direction and lift fitting out of track.

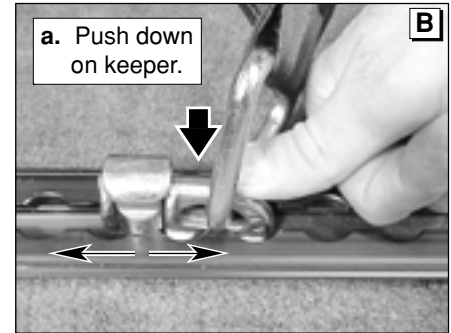

b. Slide keeper 1/2 slot in either direction.

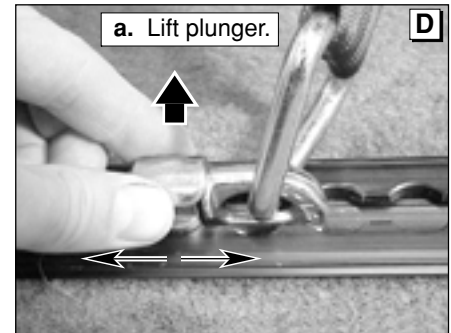

b. Slide keeper and lift.

**WHEELCHAIR AND OCCUPANT RESTRAINT**

**Figure 3**

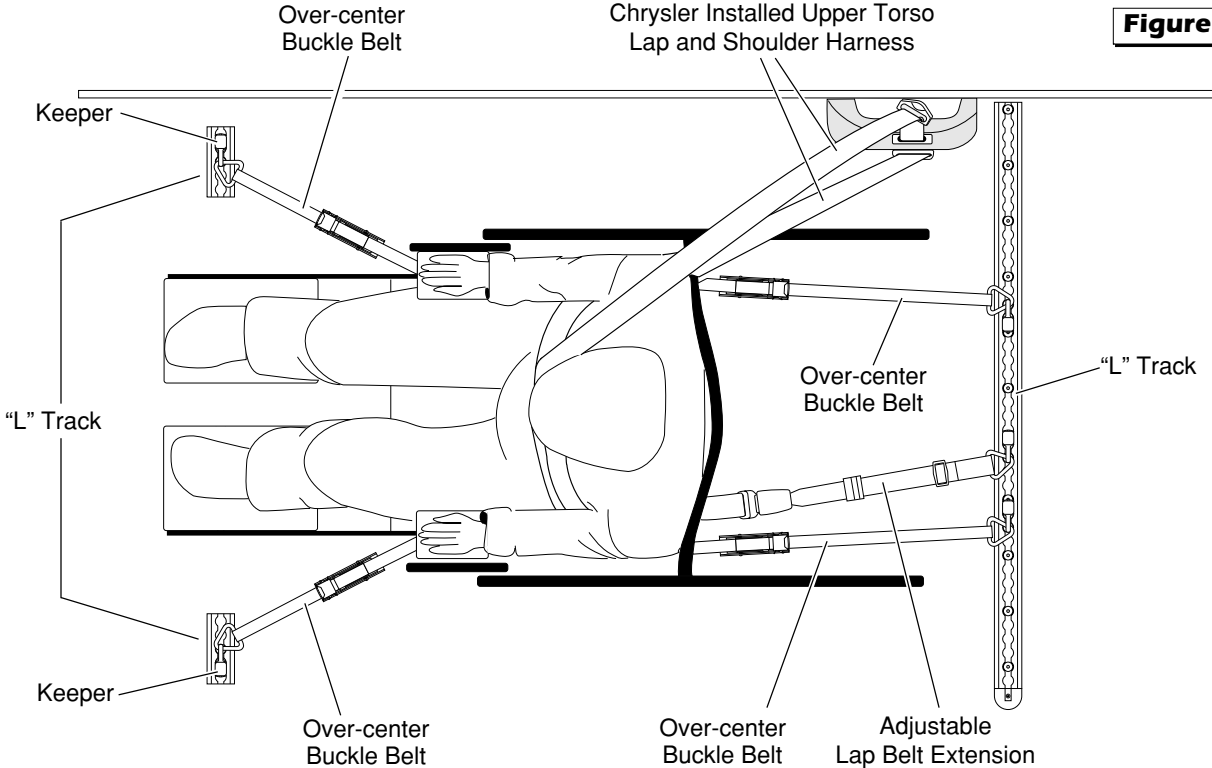

## WHEELCHAIR AND OCCUPANT RESTRAINT

**Note:** Passenger side front seat position shown. Attachment procedures are identical for all positions. Photos on pages 30 and 31 depict securement of wheelchair in midpoint position.

Keeper attachment details are provided on page 27.

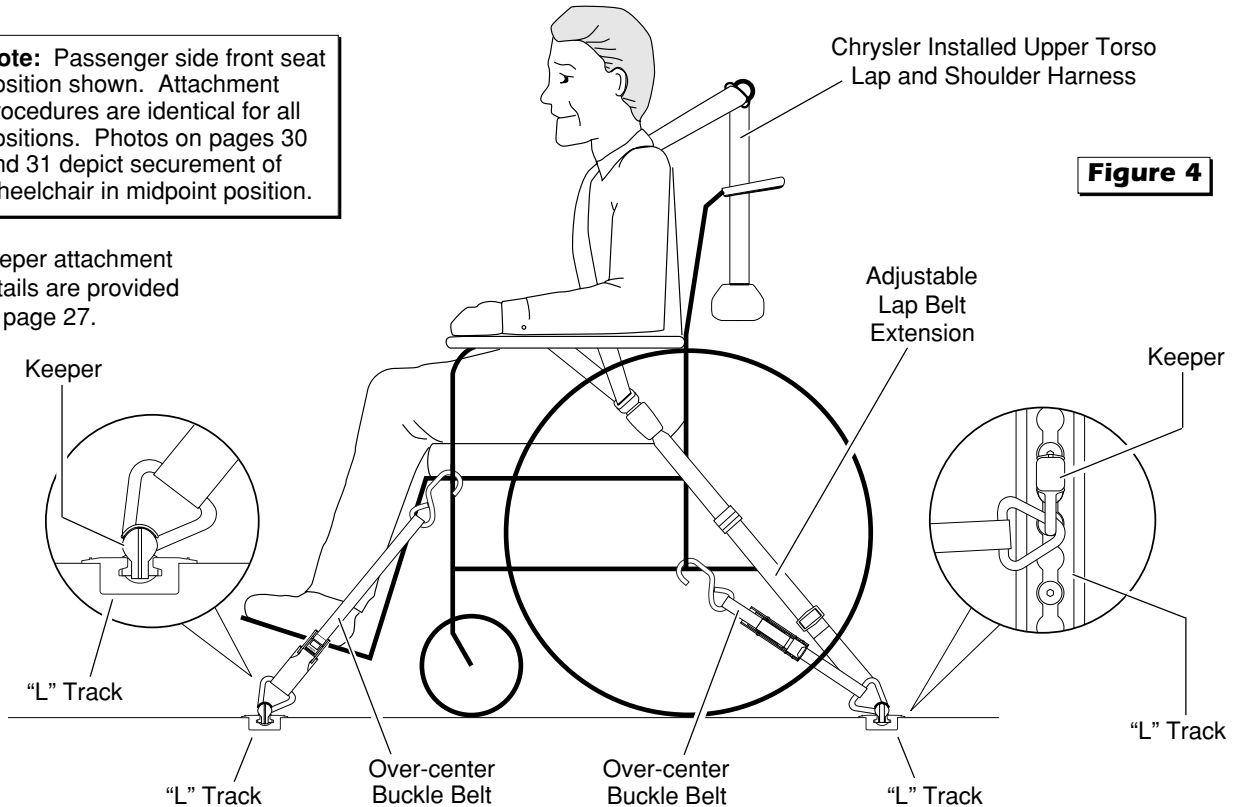

**Figure 4**

## WHEELCHAIR AND OCCUPANT RESTRAINT



### Over-Center Belt Attachments

1. Connect chair hook to a solid frame member of the wheelchair (as shown in Photo E).

2. Position and connect belt keeper fitting (attachment) to appropriate track anchorage point (slots). Attach keeper as detailed on page 27.

Pull firmly on belt to ensure fitting is locked in track.

**Note:** Belt angles should be as shown in Figure 2.

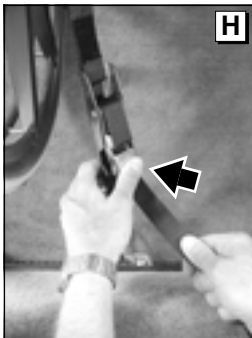
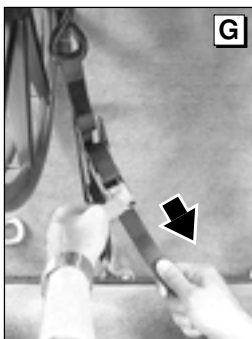

3. With buckle open, pull loose end of belt until tight (see Photo G). While holding the loose end with one hand, close the lever of the clamp (buckle) down until it locks. See Photo H.

4. Connect Velcro™

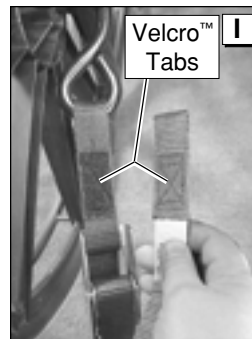

**Belt Release:** Press lever clamp (lock) to release tension on belt.



Repeat procedures for all belts.

**Note:** Check to see that front and rear belts are tight and the chair is secure enough that it does not have any movement. Lock wheelchair brakes.





Extension Belt

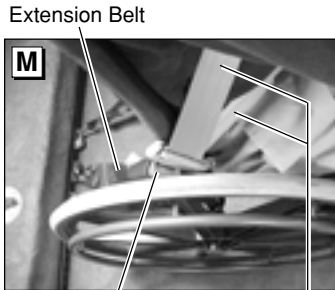

Extension Belt

Receptacle

Chrysler Lap and Shoulder Belt

### Lap and Shoulder Belt Attachments

Refer to Photos K-N.

1. Position and connect the adjustable lap belt extension keeper fitting (attachment) to appropriate track anchorage point (slots). Attach keeper as detailed on page 27. Pull firmly on belt to ensure fitting is locked in track.
2. Connect the lap and shoulder belt to the lap belt extension (insert latch plate in female receptacle). Position the upper torso (shoulder) belt across the center of the shoulder. Position the lap belt low across the front of the pelvis (near hip). See Photos K-N.

Wheelchair occupant restraints should not be held away from the body by wheelchair components such as wheelchair armrests or wheels.

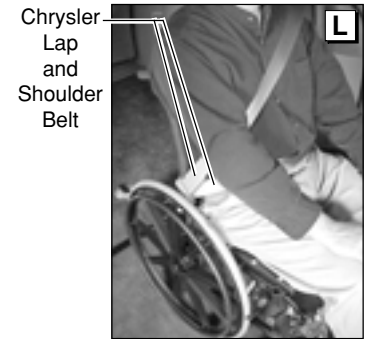

Chrysler Lap and Shoulder Belt

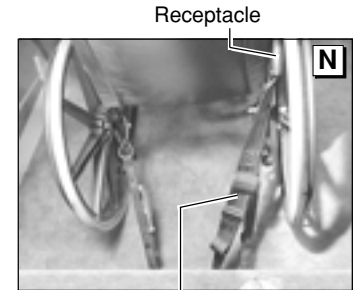

Receptacle

Extension Belt

## SEAT REMOVAL AND INSTALLATION

**Front Seats:** In an effort to produce vehicles that can be configured to meet a variety of customer needs, the driver and passenger seat bases have been designed so they may be removed. This feature allows the owner and sales representative to determine the appropriate seating arrangement to accommodate owner needs. Once the desired seat arrangement is determined, the dealer should reconnect all power seat electrical harnesses to the appropriate fixed seat positions (details at right).

Entervan front seats are available with two types of seat base securement devices. Seats may be equipped with Chrysler's Easy-Out Roller seat base attachments. Front seats can also be equipped with a bolt-in seat base (optional).

Standard Arrangement: Driver's and passenger's side seats are normally equipped with Chrysler's Easy-Out Roller seat base attachments that engage recessed floor strikers (supports). The Easy-Out Roller front seat is installed and removed as detailed in your Chrysler owner's manual and on

pages 39 and 40 of this manual. Front seats can be equipped with a bolt-in seat base (optional). Instructions for removal and installation of the bolt-in front seat base are provided on pages 41-43.

**Power Seats:** Your vehicle may be equipped with optional equipment such as power seats, heated seats, air bags, etc. **Before removing seats, be certain all seat electrical harnesses are disconnected.** When positioning seats, it is your responsibility to reconnect all seat electrical harnesses. Further details regarding power seat electrical wiring harnesses and the receptacle station are provided on pages 34-38.

### CAUTION

**Disconnect seat wiring harness before removing seat. Failure to do so may result in property damage.**

### Seat Base Rear Covers:

Entervan front seats are equipped with carpeted rear seat base covers. The covers must be removed when removing and installing seats. Refer to photos at right. Simply pull back on the covers to remove them. Align and push covers into position when reinstalling seats.

Carpeted Seat  
Base Cover

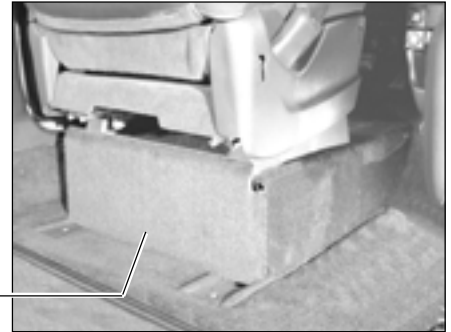

Cover  
Pulled Back

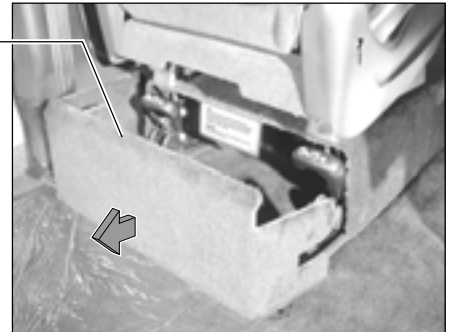

## SEAT REMOVAL AND INSTALLATION

### Front Seat Removal and Installation

#### Front Seat Wiring Harness

**Receptacle Station:** Entervan front seats are equipped with electrical wiring harnesses to accommodate optional equipment such as heated seats, air bags, etc. An electrical harness receptacle station is located directly under the dash center console (effective 9-19-01).

#### **⚠ CAUTION**

**Disconnect seat wiring harness before removing seat. Failure to do so may result in property damage.**

**Before removing seats,** be certain all seat wiring harnesses are disconnected. When front seats are removed, resistor sockets must be installed in receptacle station sockets (detailed in this supplement). When positioning seats, all front seat electrical harnesses must be reconnected.

Seat wiring harnesses route from the front end of the seat base to the receptacle station. Access and operate wiring harness connectors and resistor sockets as detailed on pages 35-38. Refer to pages 39-43 for details regarding removal and installation of front seat bases.

Failure to properly connect power seat electrical harnesses or install resistor sockets may

result in power seat functions being disabled and/or the air bag light illuminating.

Contact your sales representative or call The Braun Corporation at 1-800-THE LIFT if any of this information is not understood.

#### **⚠ WARNING**

**Park vehicle and turn engine off before removing or installing seats. Failure to do so may result in serious bodily injury and/or property damage.**

## SEAT REMOVAL AND INSTALLATION

**Receptacle Station:** An electrical harness receptacle station is located directly under the dash center console. A plastic cover conceals the station.

The cover is snapped into place. There is an engagement tab at floor level and two dimples at the top front end of the cover (one on both sides). Simply slide the cover rearward to remove it. Align the floor level tab with the floor bracket and slide forward to engage cover.

Front power seats may be equipped with one or two wiring harnesses (per seat options). Each harness is equipped with a different type of connector (or connectors). **Carefully** disconnect and connect each harness as outlined.



Plastic Cover

Receptacle Station



Driver  
Seat  
Harness

Memory  
Harness

Passenger  
Seat  
Harness

Both front seat standard electrical harnesses are equipped with two types of connectors (one round screw-on type connector and one yellow slide-together type connec-

tor). Power seats equipped with the memory feature will have an additional wiring harness. This wiring harness is equipped with a screw-on connector.

## SEAT REMOVAL AND INSTALLATION

### Screw-on Connectors

Connecting and disconnecting procedures for all three screw-on connectors is the same, but the pin configuration is different for each connector. The seat wiring harness connectors must be connected to the specified receptacle socket.

Alignment grooves (slots) are provided in receptacle station sockets. Seat wiring harness plugs are equipped with mating alignment guides (ears).

**Note:** Each receptacle station socket has a single wider alignment groove that is positioned at 12 o'clock (shown at right). Use this feature as an alignment guide. Operate connectors as detailed on the following page.

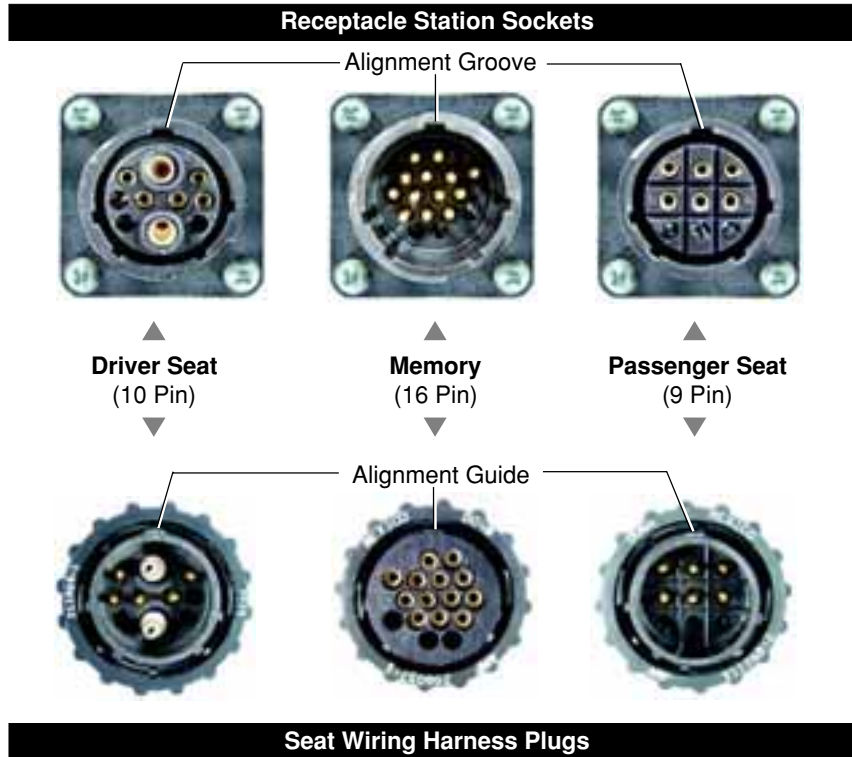

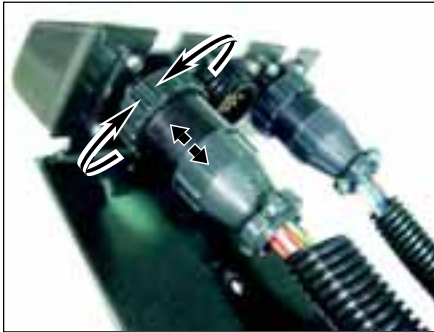

### Screw-On Connector Instructions

**To Connect:** Align the seat harness connector alignment guides with the receptacle socket alignment grooves (will only connect one way). **Carefully** insert the seat harness connector in the receptacle socket. Turn seat harness connector **inside** knurled grip clockwise fully.

**To Disconnect:** Turn seat harness connector **inside** knurled grip counterclockwise and disengage connectors.

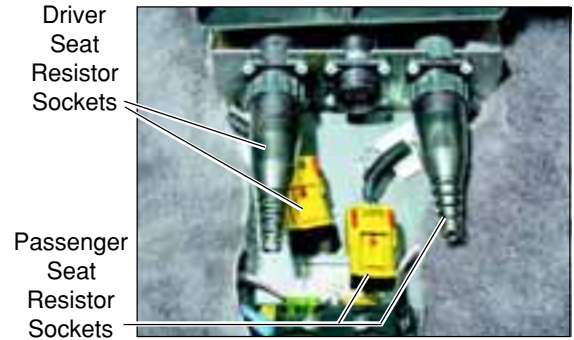

### Resistor Sockets

When front seats are removed, resistor sockets must be installed in receptacle station connectors. A resistor socket is supplied for each seat electrical harness except the memory harness (center connectors). Connect each resistor socket to the applicable receptacle station connector as detailed when seats are removed. The photo above depicts resistor sockets installed in all receptacle connectors. Screw-on resistor sockets are connected and disconnected as outlined at left.

## SEAT REMOVAL AND INSTALLATION

### Yellow Slide-Together Connector Instructions

Photos on this page depict resistor sockets being connected to receptacle station sockets. Connecting and disconnecting procedures are identical for seat wiring harness sockets.

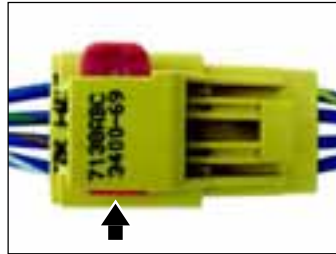

a. Slide red lock until visible on one side only and you **hear a click**.

To  
Disconnect

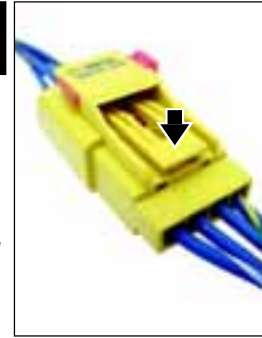

b. Press yellow lock and disengage connectors.

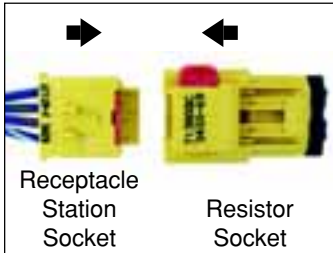

a. With red lock open, align and engage resistor socket with receptacle station socket.

To  
Connect

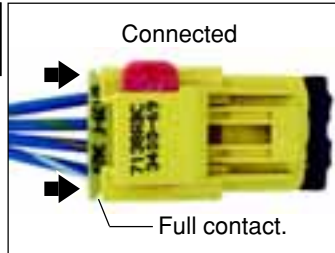

Engage sockets fully (full contact) until you **hear a click**.

To  
Connect

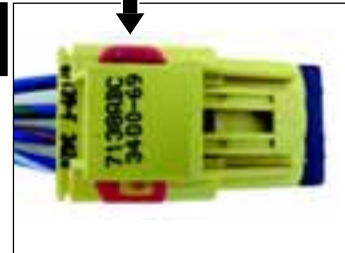

b. Slide red lock.



### Easy-Out Roller Seat Base

Chrysler's Easy-Out Roller seat base attachments engage recessed floor strikers (supports). Two release handles are located at the rear of the seat base. Squeezing the handles and rotating the handles downward disengages the attachments and deploys the wheels. A lock indicator button pops up when the seat is unlocked.

Squeezing the handles and rotating the handles upward engages the attachments. The indicator button returns into the handle when the attachment mechanism is in the fully-engaged position (seat base attachments are fully-engaged with floor strikers). See page 40 for Easy-Out Roller Seat Removal and Installation Instructions.

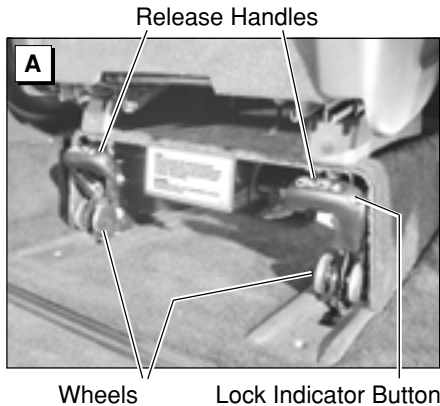

Tip seat back and roll out of vehicle.



## SEAT REMOVAL AND INSTALLATION

### Easy-Out Roller Seat Removal Instructions

1. **Caution! Disconnect seat wiring harnesses before removing seats** (if applicable). See pages 34-38 for wiring harness and receptacle station details and photos. Easy-Out photos on page 39.
2. Squeeze the release handles located at the rear of the seat base and rotate downward. Rotate the handles down **fully** until the handles reach the locked (horizontal) position and the indicator buttons return into the handles (see Photo A).  
  
**Note:** A lock indicator button pops up when the seat is unlocked (midpoint of handle rotation). The indicator buttons return into the handles when the handles are rotated fully down (seat base attachments are fully disengaged from floor strikers and wheels are deployed).
3. Tip seat slightly backwards and roll seat base out of vehicle. See Photos B and C. **Caution: Do not contact the ramp when reclining or moving seats. Doing so may result in property damage.**

### Easy-Out Roller Seat Installation Instructions

1. Roll seat base into position (aligning the seat base attachments with the recessed floor strikers).
2. Squeeze the release handles located at the rear of the seat bases and rotate upward to latch the seat base attachments with the recessed floor strikers (receptacles). Rotate the handles up and fully forward until the handles reach the locked position and the indicator buttons return into the handles. See Photo A.
3. Connect (plug) the electrical harness sockets. See pages 34-38 for details.

#### **WARNING**

**Seat attachments must be fully latched in floor supports before occupying seats or operating vehicle. Failure to do so will result in serious bodily injury.**

**Bolt-in Front Seat Base:**

The bolt-in seat base is equipped with four front-facing hook type attachments (two in front and two in rear). These attachments engage the recessed floor strikers. Rear-facing hook type attachments (plates) are bolted to the two seat base side plates (at rear). The rear-facing hook plates engage the recessed floor strikers also. The opposing hooks lock the seat in place.

Each of the rear-facing hook plates is secured with one 7/16-20 x 1" hex bolt (adjustment bolt). Turning the bolt clockwise draws the rear-facing hook rearward to lock the seat base in place. Turning the adjustment bolt counterclockwise moves the rear-facing hook forward to allow seat removal. The rear-facing hook plates must be removed in order to remove the seat. Remove and install the bolt-in seat base as outlined

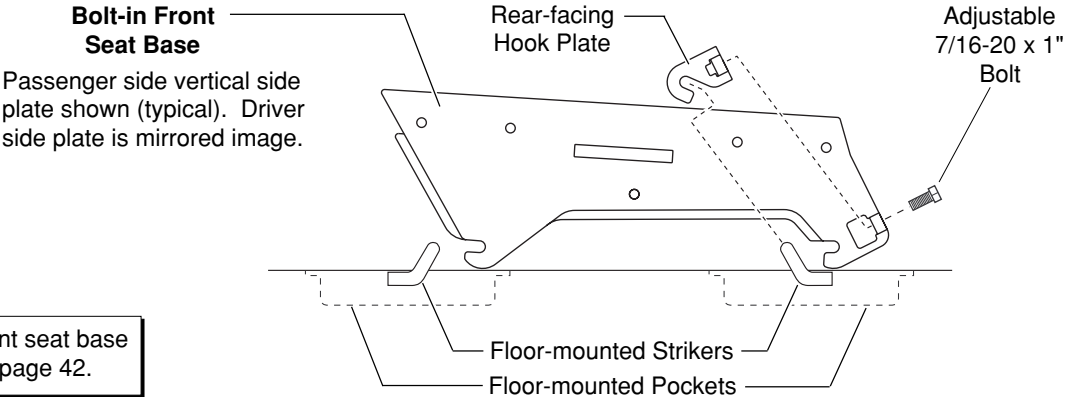

**Note:** Front seat base photos on page 42.

## SEAT REMOVAL AND INSTALLATION

### Bolt-in Front Seat Base:

#### Bolt-in Front Seat Base

Driver side vertical side plate shown (typical). Passenger side plate is mirrored image.

**Note:** Front seat base illustration on page 41.

Bolt-in Front Seat Base and Side Plate

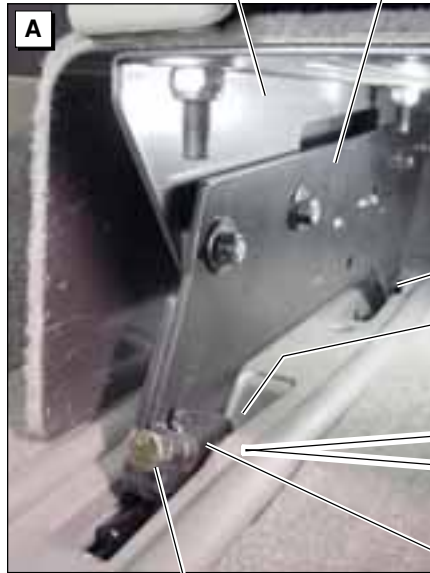

Adjustable 7/16-20 x 1" Hex Bolt



Adjustable 7/16-20 x 1" Hex Bolt

Rear-facing Hook Plate

Rear-facing Hook Plate

### Bolt-in Front Seat Removal Instructions:

1. **Caution! Disconnect seat wiring harnesses before removing seats** (if applicable). Electrical wiring harness sockets are connected to the receptacle station located directly under the dash center console. See pages 34-38 for receptacle station details and photos.
2. Turn the 7/16-20 x 1" hex bolt counterclockwise to disengage and remove the two rear-facing hook plates.
3. Remove the two rear-facing hook plates.
4. **Carefully** remove the seat.

**Note:** Resecure rear-facing hook plates to seat base or store hook plates and mounting hardware for reinstallation.

**Note:** Refer to front seat base illustration and photos on pages 41 and 42.

### Bolt-in Front Seat Installation Instructions:

1. Position seat (align the four front-facing hook attachments with the recessed floor strikers). Shift seat **fully** forward (be certain the front-facing hook plates **engage strikers fully**).
2. Position the rear-facing hook plate to inside of the rear front-facing hook plate (typical both sides).
3. Insert the 7/16-20 x 1" hex bolt. Turn the bolt clockwise to engage and tighten the rear-facing hook fully.  
**Both** opposing **hooks** (front-facing and rear-facing) **must contact the rear striker fully**.
4. Connect (plug) the electrical harness sockets. See pages 34-38 for details.

### **WARNING**

**Install seats as specified before occupying seats or operating vehicle. Failure to do so may result in serious bodily injury and/or property damage.**

## SEAT REMOVAL AND INSTALLATION

### Bolt-in Rear Seat Base:

Lowered rear bolt-in seat bases are equipped with four front-facing hook type attachments (two in front and two in rear). These attachments engage the recessed floor strikers. Rear-facing hook type attachments (plates) are bolted to the two seat base side plates (at rear). The rear-facing hook plates engage the recessed floor strikers also. The opposing hooks lock the seat in place.

Each of the rear-facing hook plates is secured with one 7/16-20 x 1" hex bolt (adjustment bolt). Turning the bolt clockwise draws the rear-facing hook rearward to lock the seat base in place. Turning the adjustment bolt counterclockwise moves the rear-facing hook forward to allow seat removal. Remove and install the bolt-in seat base as outlined.

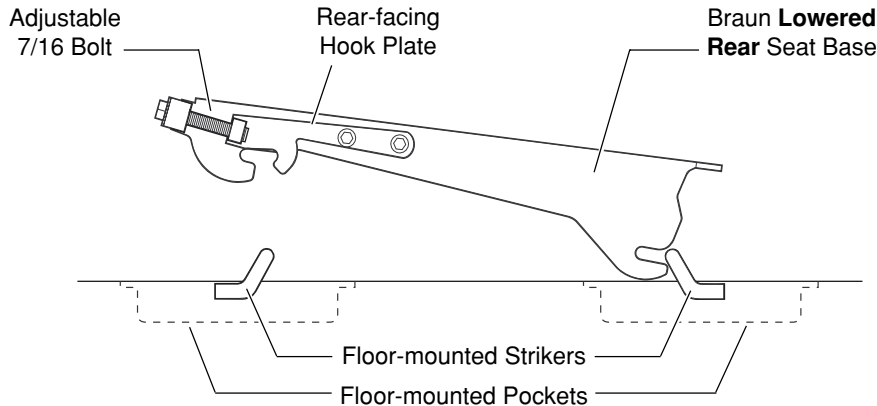

### **⚠ WARNING**

**Install seats as specified before occupying seats or operating vehicle. Failure to do so may result in serious bodily injury and/or property damage.**

## SEAT REMOVAL AND INSTALLATION

### Bolt-in Rear Seat Installation Instructions:

1. Position seat (engage front striker and align rear striker).
2. Shift seat base **fully** forward (be certain the front-facing hook plates **engage strikers fully**).
3. Turn the 7/16-20 x 1" hex bolt clockwise to engage and tighten rear-facing hook fully. **Both** opposing **hooks** (front-facing and rear-facing) **must contact the rear striker fully**.

### Bolt-in Rear Seat Removal Instructions:

Reverse above procedurses.

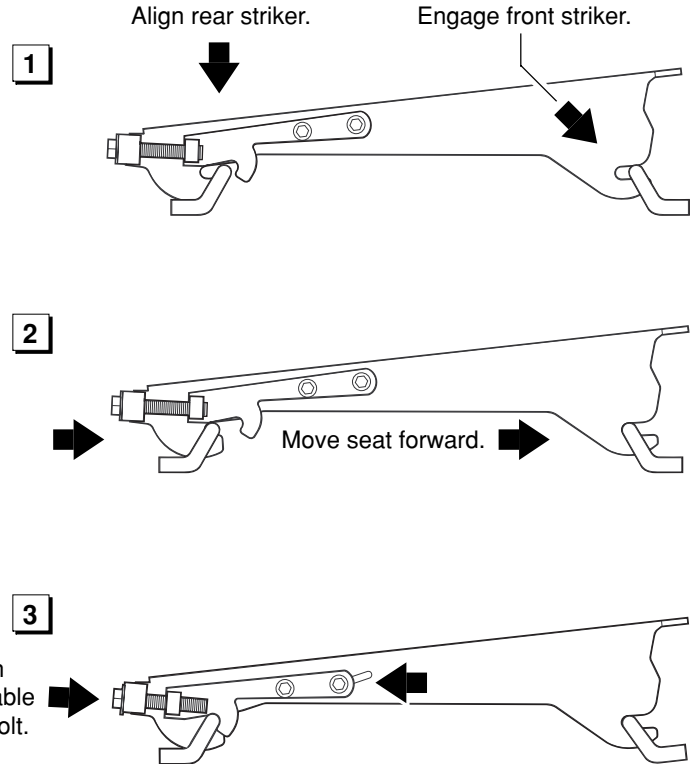

## WARRANTY

□ In accordance with the Chrysler 7 year/100,000 mile corrosion warranty, The Braun Corporation warrants to the purchaser of its Entervan conversion that the metal fabrication on or of the frame, floor and lowered door extension are free from defects in material and factory workmanship for a period of 7 years or 100,000 miles on the odometer, whichever occurs first. The Braun Corporation further warrants to the purchaser that the remainder of the modifica-

tions and alterations for associated parts are free from defects in material and workmanship for a period of 36 months or 36,000 miles, whichever comes first. For clarification purposes, the following chart outlines The Braun Corporation Entervan warranty coverage. Refer to your Chrysler warranty information booklet for all Chrysler OEM (factory) limited warranty details.

Years/Miles in Service	Specific Area Covered
<p style="text-align: center;"><b>36 Months</b> or <b>36,000 Miles</b> (whichever comes first)</p>	<p>Entervan frame and floor structural components</p> <p>Entervan ramp, door and associated structural components</p> <p>Entervan electrical components including but not limited to switches, wires, connectors and the controller</p> <p>Entervan electromechanical kneel systems including but not limited to electric actuator, chain, pulleys and associated hardware</p>



<b>Years/Miles in Service</b>	<b>Specific Area Covered</b>
<p><b>36 Months</b>  <b>or</b>  <b>36,000 Miles</b>                      (whichever comes first)</p>	<p>Entervan appearance items including but not limited to interior floor covering and slide door lowered extension assemblies.</p>
<p><b>7 Year</b>  <b>or</b>  <b>100,000 Miles</b>                      (whichever comes first)  <b>Corrosion</b>  <b>Warranty</b>                      see *Exceptions at right</p>	<p><b>Corrosion Warranty:</b></p> <p>Entervan frame, floor and lower door modification metal fabrication corrosion applies to perforation only. Entervan lower slide door modification corrosion applies to outer-body sheet metal and paint. Perforation is a rust-through condition such as an actual hole in the metal.</p> <p>* Exceptions: Cosmetic or surface corrosion (resulting from stone chips for example) would not be covered or repaired under this coverage. If corrosion does not cause holes, and is not the result of usage and/or environmental conditions, repair coverage lasts for 3 years or 36,000 miles, whichever comes first.</p>

## WARRANTY

- Both the 7 year/100,000 mile corrosion and the 3 year/36,000 mile warranties described on previous page commence on the date the conversion is put into service, providing the warranty registration card is completed and received by The Braun Corporation within thirty days of the purchase.
- The Braun Corporation agrees to repair or replace any of its Entervan factory-installed parts found to be defective within the appropriate warranty period or mileage. This warranty also covers the cost of labor for the repair or replacement of said parts for one year provided that the repair is authorized by The Braun Corporation and carried out by an authorized service establishment (a Braun labor schedule determines the cost allowance for repairs). The Braun Corporation will not honor any warranty claim for repairs or replacement of parts unless the claim is submitted with the appropriate factory warranty authorization data and the repairs or replacement of the parts are completed by a factory-authorized repairman. The factory authorization data, together with the name and location of the factory-authorized repairman, can be obtained by

either written or telephone contact with The Braun Corporation at the addresses appearing in this manual.

- The return authorization procedure must be adhered to in order to process any warranty and repair claims (details below).
- The Braun Corporation reserves the right to designate where any warranty work is to be performed.
- The Braun Corporation also reserves the right to examine any defective workmanship or part prior to any authorization of necessary repairs. This Entervan warranty is not intended to replace or substitute any other warranties issued by the original manufacturer of the vehicle or other suppliers of components. This warranty shall not apply to any part or workmanship that may become defective due to misuse, neglect, accident or other casualty, modifications or alterations or unauthorized repairs. Further, this warranty shall not extend to parts or workmanship that may become defective because of the failure of

anyone to operate the same in accordance with the printed instructions of The Braun Corporation or because of operation of the same beyond its capacity.

This warranty does not cover normal maintenance, service, or periodic adjustments necessitated by use or wear.

Second buyers of a Braun Entervan conversion may transfer the remaining warranty, if any, by obtaining a transfer of warranty application from The Braun Corporation. This application must be returned to The Braun Corporation within thirty days from the date you purchase the vehicle and proof of the date of purchasing must be supplied with the transfer of warranty application. There will be a minimum warranty transfer fee.

The Braun Corporation shall not be liable for any incidental or consequential damages resulting from any breach of warranty.

The Braun Corporation shall not be liable for towing charges, travel and lodging, or any other expense incurred due to the loss of use of vehicle or other reason.

## PREVENTIVE MAINTENANCE

Maintenance is necessary to ensure safe and trouble-free Entervan operation. General preventive maintenance consisting of inspections of your Entervan systems along with cleaning and lubricating procedures should be a part of your routine (lubrication requirements are minimal). Regular preventive maintenance procedures will increase the service life of the Entervan, as well as enhancing safety.

During routine inspections, operate all Entervan systems and note the following (as equipped):

- Is the power source adequate or weak?
- Does the electronic control system function properly?
- Do the control switches function properly?
- Does the kneel feature function

properly?

- Does the power door function properly?
- Does the ramp unfold and fold properly?
- Inspect wheelchair and occupant restraint belts, buckles and hardware for damage, wear, abnormal condition or improper operation.

Entervan ramps are equipped with sealed bearings and Teflon™ bushings to decrease wear, provide smooth operation and extend the service life of the ramp. These components do not require lubrication under normal conditions (although the ramp should be inspected and cleaned routinely).

Light oil should be applied to the outboard ramp extension hinge, the kneel actuator manual release

assembly and the Swing-Out ramp latch (as equipped). Clean the components and the surrounding area before applying lubricants. LPS2 General Purpose Penetrating Oil is recommended by and available from the Braun Corporation (part number 15807). Use of improper lubricants can attract dirt or other contaminants which could result in wear or damage to components.

Clean and lubricate the specified points approximately every four weeks or 100 cycles. These intervals are a general guideline and will vary according to frequency of use and conditions. Exposure to severe conditions (weather, environment, heavy usage, etc.) may require inspection and maintenance procedures to be performed more often.

Preventive maintenance visual inspections, cleaning and lubrication procedures **do not** take the place of the procedures specified in the Maintenance and Lubrication Schedule provided in the Entervan service manual. The procedures

### **⚠ WARNING**

**Maintenance and lubrication procedures must be performed by authorized service personnel as specified in the applicable Entervan service manual. Failure to do so may result in serious bodily injury and/or property damage.**

outlined in the Maintenance and Lubrication Schedule **must be performed at the recommended scheduled intervals by an authorized Braun Corporation service representative who has attended and been certified by The Braun Corporation Sales and Service School.**

If there is any sign of damage, wear, abnormal condition or improper operation, **discontinue Entervan use immediately.** Contact your sales representative or call The Braun Corporation at 1-800-THE LIFT. One of our Product Support representatives will direct you to an authorized service technician who will inspect your Entervan.

### **Jacking and Tire Changing**

**Interior Spare Tire Mount:** The spare tire is mounted behind the rear bench seat. The jack is stored with the spare tire.

### **Jacking and Tire Changing**

**Procedures:** Jacking and tire changing procedures have not been affected by the conversion. If the rear of the vehicle is in the kneeled position, raise the rear of the vehicle to normal position before jacking.

Detailed tire changing instructions are provided in the Chrysler-supplied owner's manual. **Refer to the Chrysler-supplied manual for tire changing instructions and safety precautions, as well as instructions regarding other roadside emergencies.**

## AUXILIARY POWER SUPPLY / BELOW FLOOR OBSTRUCTIONS

**Note:** The technical information provided on pages 52-54 of this manual is service related. If you are having an electrical tie-down, power seat or other auxiliary electrical device installed in your Entervan, this information should be supplied to the technician. Otherwise, disregard this section.

### ⚠ CAUTION

**Do not connect auxiliary devices to vehicle battery. Doing so may result in damage to electrical system and/or electronic components.**

### Auxiliary Power Supply

**Do not** connect auxiliary devices directly to the vehicle battery. Doing so **may result in damage to electrical system and/or electronic components.**

A fuse block that can accommodate up to five additional ATO® type fuses is provided as an auxiliary power source. This power source is available for installation of a dealer-installed power seat, an electric tie-down or other auxiliary electrical device.

The fuse block is located on the floor below the dash center console in Series 03 Entervans (shown in photo at right). Remove the plastic cover to access the fuse block.

25 Ampere Fuse      Female Spade Terminal

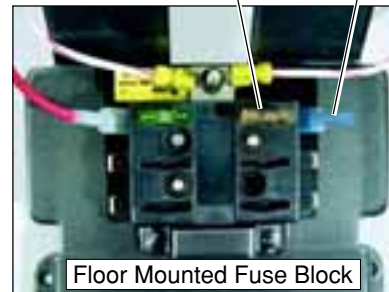

The **installer is responsible for supplying the correct gauge wire and fuse** for the particular device to be attached to the fuse block (**as specified** by the manufacturer of the device). The **maximum load must not exceed 25 amperes.**

Wires with female fully-insulated terminals can simply be connected

## AUXILIARY POWER SUPPLY / BELOW FLOOR OBSTRUCTIONS

to one of five available terminals on the fuse block. A female terminal and 25 ampere fuse is



provided at top right fuse position for this purpose (as shown).

**Note:** A 30 ampere fuse is factory installed in the top left receptacle for protection of the One-Touch electronic control module. Fuses installed in all other fuse positions must not exceed 25 amperes.

### Below-Floor Obstructions

When installing an electrical tie-down, power seat or other auxiliary electrical device in an Enter-van, obstructions below the floor must be avoided. Obstructions include wiring, fuel system, brake lines, etc. Installers must be aware of these obstructions.

Refer to the illustration on the following page when installing aftermarket equipment to avoid

contacting or damaging vital components under the floor. **Drilling or cutting into such obstructions may result in potential hazards as well as property damage.**

**Note:** Some wiring harnesses shown may not be present. Avoid all harness locations.

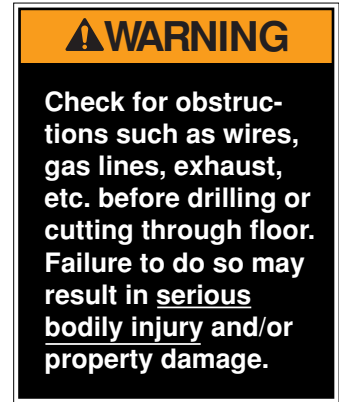

# AUXILIARY POWER SUPPLY / BELOW FLOOR OBSTRUCTIONS

## Below-Floor Obstructions

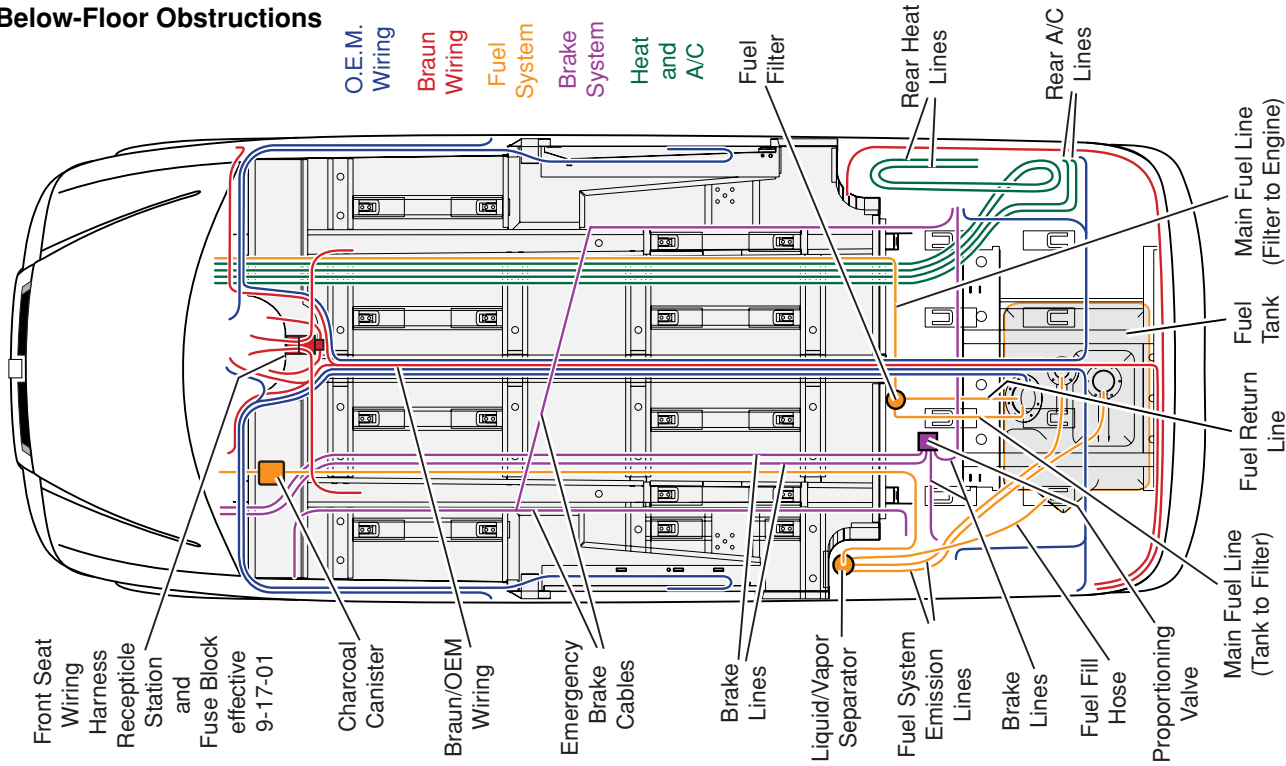



**"Providing Access to the World"®**

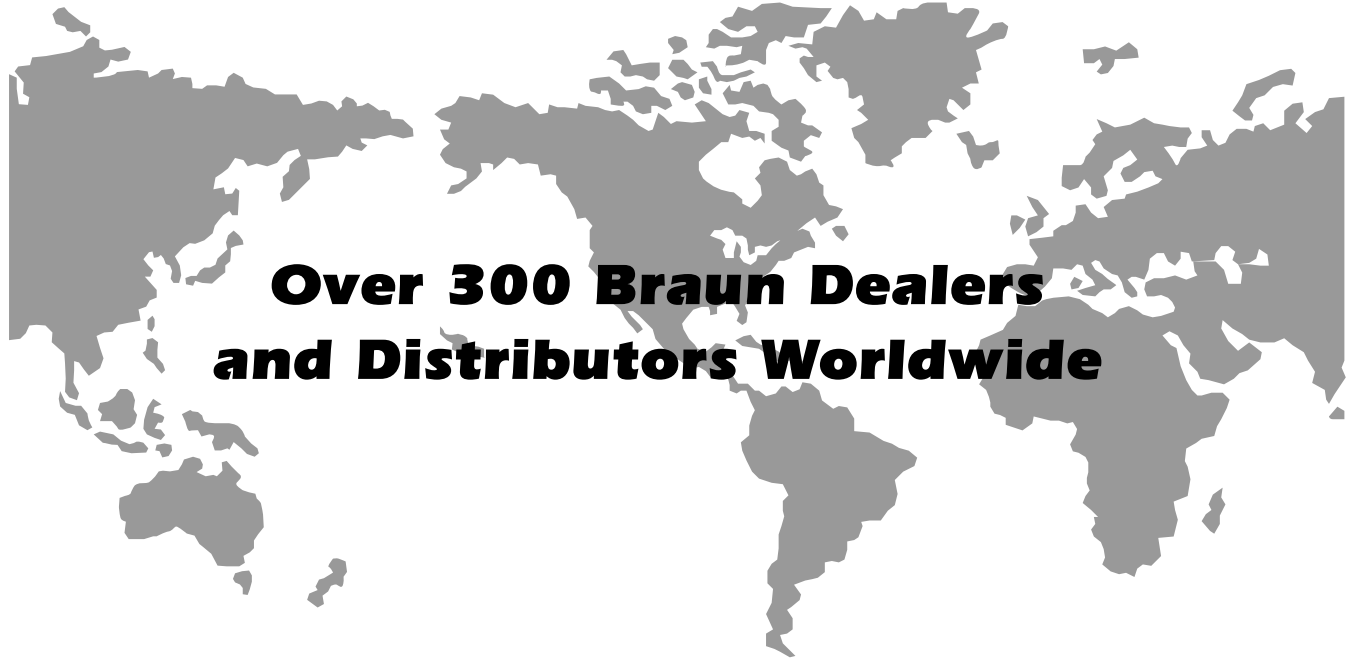

**Over 300 Braun Dealers  
and Distributors Worldwide**

# Operator's Manual for:

2001 and Newer

BRAUN



ENTERVAN



"Providing Access to the World"®

International Corporate Hdqrs: P.O. Box 310 Winamac, IN 46996 USA  
1-800-THE LIFT (574) 946-6153 FAX: (574) 946-4670



27854  
June 2002



Braun Entervan® II

All illustrations, descriptions and specifications in this manual are based on the latest product information available at the time of publication. The Braun Corporation reserves the right to make changes at any time without notice.